

moda



— — — — — a project featuring — — — — —

**RUE 1800**

by  
*3 Sisters*

72" x 72"





A project featuring

by *3 Sisters* *moda*

## PATTERN NOTES

**Finished size:** 72" x 72"

**Star Blocks size:** 12" x 12"

## CUTTING INSTRUCTIONS

*Label all the pieces as they are cut.*

### Taupe/Gray Prints for Star Points



1 Fat Eighth of each

From each of the fabrics, cut the following:

- 2 strips –  $3\frac{7}{8}$ " x 21"
- Subcut 8 squares –  $3\frac{7}{8}$ " x  $3\frac{7}{8}$ ". 52 squares are needed; you will have 4 left over.

### Pink Prints for Star Points and Border Blocks



1 Fat Quarter of each

From each of the fabrics, cut the following:

- 2 strips –  $3\frac{7}{8}$ " x 21".
- Subcut 8 squares –  $3\frac{7}{8}$ " x  $3\frac{7}{8}$ ".
- 1 strip –  $7\frac{1}{4}$ " x 21".
- Subcut 2 squares –  $7\frac{1}{4}$ " x  $7\frac{1}{4}$ ". 10 squares are needed; you will have 2 leftover.

### Aqua Prints for Block Centers and Border Triangles



1 Fat Quarter of each

From each of the fabrics, cut the following:

- 1 strip –  $4\frac{3}{4}$ " x 21".
- Subcut 4 squares –  $4\frac{3}{4}$ " x  $4\frac{3}{4}$ ".
- 1 strip –  $7\frac{1}{4}$ " x 21".
- Subcut 2 squares –  $7\frac{1}{4}$ " x  $7\frac{1}{4}$ ". 10 blocks are needed; you will have 2 left over.

### Aqua Prints for Block Centers



1 Fat Eighth

- Cut 1 strip –  $4\frac{3}{4}$ " x 21".
- Subcut 4 squares –  $4\frac{3}{4}$ " x  $4\frac{3}{4}$ ".

### Ivory Prints for Block Backgrounds and Border Blocks

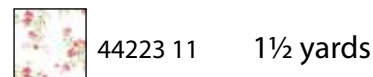

- Cut 1 strip –  $7\frac{1}{4}$ " x 42".
- From the strip, cut 4 squares –  $7\frac{1}{4}$ " x  $7\frac{1}{4}$ ".
- Cut 2 strips –  $3\frac{1}{2}$ " x 42".
- From the strips, cut 16 squares –  $3\frac{1}{2}$ " x  $3\frac{1}{2}$ ".
- Cut 4 strips –  $6\frac{7}{8}$ " x 42".
- From each strip, subcut 5 squares –  $6\frac{7}{8}$ " x  $6\frac{7}{8}$ ", and 1 square –  $6\frac{1}{2}$ " x  $6\frac{1}{2}$ ".
- Cut 1 strip – 4" x 42".
- From the strip, cut 6 squares – 4" x 4".

## Ivory Prints – cont.



44224 11



44228 21



44228 22

$\frac{2}{3}$  yard each

From each of the fabrics, cut the following:

- 2 strips –  $7\frac{1}{4}$ " x 42".
  - From the 1st strip, cut 5 squares –  $7\frac{1}{4}$ " x  $7\frac{1}{4}$ ".
  - From the 2nd strip, cut 1 square –  $7\frac{1}{4}$ " x  $7\frac{1}{4}$ ".
  - From the remainder, cut 2 strips –  $3\frac{1}{2}$ " x approx. 32".
    - From each strip, cut 9 squares –  $3\frac{1}{2}$ " x  $3\frac{1}{2}$ ".
- 1 strip – 4" x 42"
  - Subcut 8 squares – 4" x 4".
- 1 strip –  $3\frac{1}{2}$ " x 42".
  - Subcut 6 squares –  $3\frac{1}{2}$ " x  $3\frac{1}{2}$ ". (24 total.)



44226 11  $\frac{1}{2}$  yard

- Cut 1 strip –  $7\frac{1}{4}$ " x 42".
  - From the strip, cut 3 squares –  $7\frac{1}{4}$ " x  $7\frac{1}{4}$ ".
- From the remainder, cut 2 strips –  $3\frac{1}{2}$ " x approx. 18".
  - Subcut 10 squares –  $3\frac{1}{2}$ " x  $3\frac{1}{2}$ ".
- Cut 1 strip – 4" x 42".
  - From the strip, cut 6 squares, 4" x 4"
  - From the remainder, cut 2 squares,  $3\frac{1}{2}$ " x  $3\frac{1}{2}$ ".



44221 11



44227 11

1 Fat Eighth of each

- Cut 4 squares – 4" x 4" from each.



44221 13

Binding - Cut 8 strips -  $2\frac{1}{2}$ " x 42"

## ASSEMBLY

All seams are a scant  $\frac{1}{4}$ ".

There are 12 pink stars and 13 taupe/gray stars. Each star block uses two different ivory prints. All 25 stars have an aqua center square.

For each block, you will need the following pieces:

- **Ivory Print for Background:** 1 square –  $7\frac{1}{4}$ " x  $7\frac{1}{4}$ " and 2 matching squares –  $3\frac{1}{2}$ " x  $3\frac{1}{2}$ ".
- **Pink or Taupe/Gray:** 4 matching squares –  $3\frac{7}{8}$ " x  $3\frac{7}{8}$ ".
- **Ivory Print for Center Triangles:** 2 squares – 4" x 4".
- **Aqua Print:** 1 square –  $4\frac{3}{4}$ " x  $4\frac{3}{4}$ ".

## Making the Flying Geese

Draw a diagonal line as shown on the wrong side of the four pink (or taupe/gray)  $3\frac{7}{8}$ " squares using a permanent pen, pencil, or fabric marker.

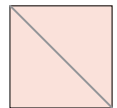

With right sides together, align two of the squares in opposing corners of the ivory  $7\frac{1}{4}$ " square as shown.

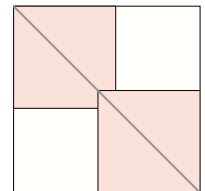

Stitch a scant  $\frac{1}{4}$ " seam allowance on both sides of the line.

Cut the square apart on the drawn line.

Press the seams toward the small triangles.

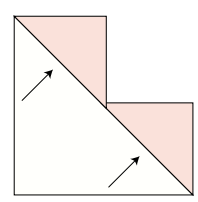
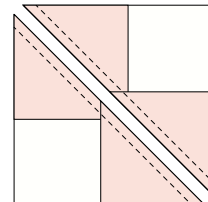
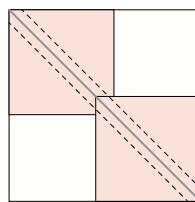

With right sides together, align one of the remaining squares on each ivory triangle as shown.

Stitch a scant  $\frac{1}{4}$ " seam allowance on both sides of the line. Cut the triangle apart on the drawn line. Press the seams toward the small triangle to make four matching flying geese units that should measure  $3\frac{1}{2}$ " x  $6\frac{1}{2}$ ".

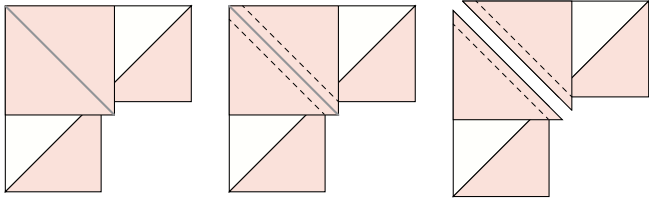

Repeat to make 25 sets of 4 matching flying geese, 12 pink and 13 taupe/gray.

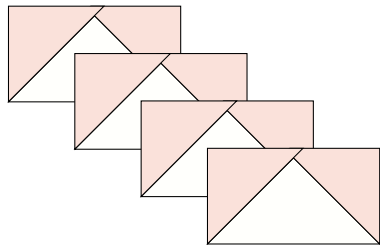

## Making the Square-In-a-Square Units

Select 2 matching 4" x 4" ivory print squares and 1 aqua  $4\frac{3}{4}$ " x  $4\frac{3}{4}$ " square.

Cut both 4" squares of ivory print 2 in half once on the diagonal as shown to yield four triangles.

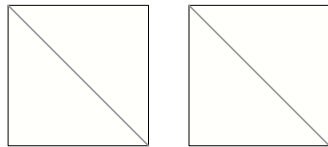

Join two triangles to opposing sides of the aqua  $4\frac{3}{4}$ " square.

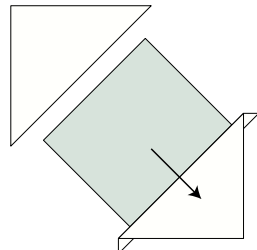

Press the seams to the triangle.

Repeat with the remaining two ivory triangles and trim the small triangles (dog ears).

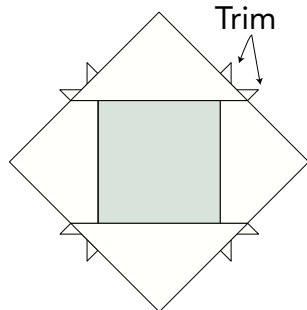

Press the seams toward the triangles.

To get proper placement – align the points of corners of the aqua square with the  $3\frac{1}{4}$ " lines on the ruler. Then trim the pieced unit to measure  $6\frac{1}{2}$ " x  $6\frac{1}{2}$ ".

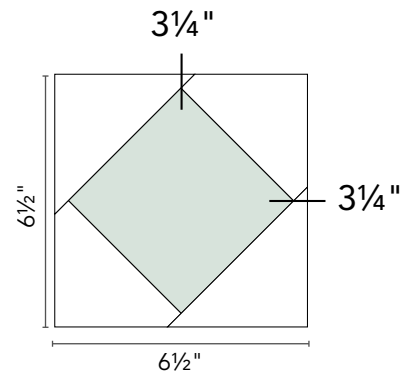

Make 25 units.

## Assembling the Star Blocks

Lay out the units and the  $3\frac{1}{2}$ " squares for the corner squares.

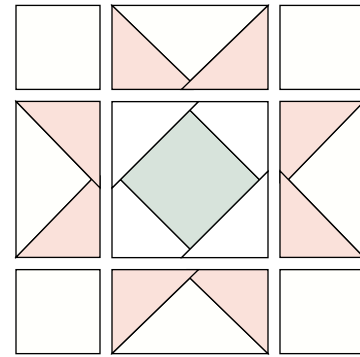

Join the pieces to make three rows.

Press all seams in the direction of the arrows – or press them open.

Join the rows to complete the block.

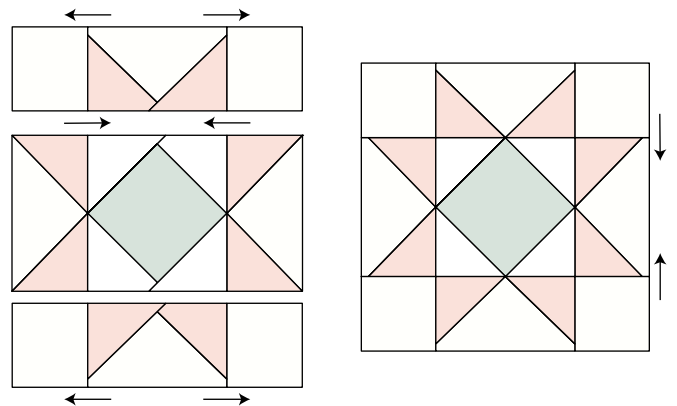

The block will measure  $12\frac{1}{2}$ " x  $12\frac{1}{2}$ ".

Repeat to make 12 blocks with Pink star points and 13 blocks with Taupe/Gray star points.

## Making the Border Blocks

Cut the 10 aqua squares and 10 pink  $7\frac{1}{4}$ " squares **twice** on the diagonal as shown to yield 40 aqua triangles and 40 pink triangles.

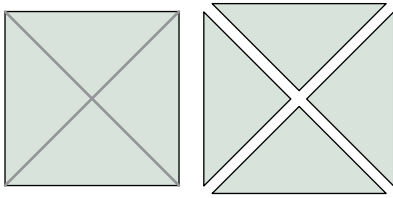

Join a pink and aqua triangle as shown.

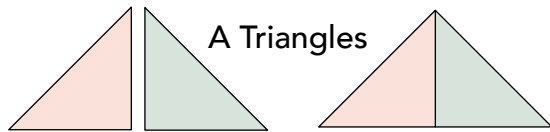

Press the seam open.

Repeat to make 20 pieced A triangles.

Join one aqua and one pink triangle as shown.

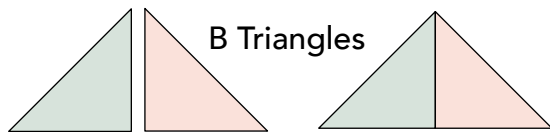

Press the seam open.

Repeat to make 20 pieced B triangles.

Cut the 20 ivory print  $6\frac{7}{8}$ " squares in half on the diagonal to yield 40 triangles.

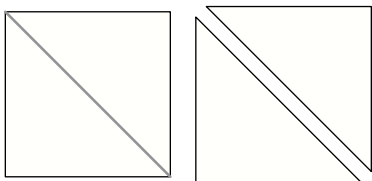

## Border Square A

Join 1 ivory print triangle to one pieced A triangle as shown.

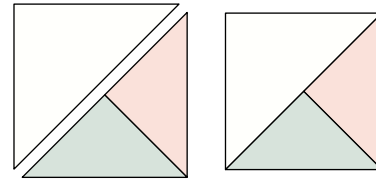

The square will measure  $6\frac{1}{2}$ " x  $6\frac{1}{2}$ ".

Repeat to make 20 A squares.

## Border Square B

Join 1 ivory print triangle to one pieced B triangle as shown.

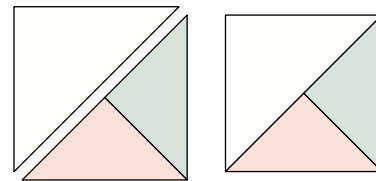

The square will measure  $6\frac{1}{2}$ " x  $6\frac{1}{2}$ ".

Repeat to make 20 B squares.

## Border Rectangles

Join 1 A Square to 1 B Square as shown.

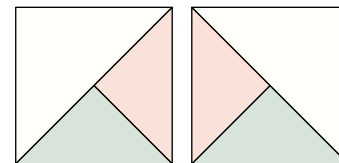

Press the seam to one side – or press it open.  
The border rectangle will measure  $6\frac{1}{2}$ " x  $12\frac{1}{2}$ ".

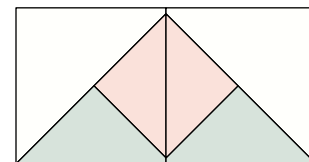

Repeat to make 20 border rectangles.

## ASSEMBLING THE QUILT TOP

Assemble the quilt in seven rows – the top and bottom border rows, and five block rows that include a border rectangle at each end.

Join the blocks to complete the rows. Press the seams in one direction, alternating the direction with each row, or press the seams open..

Using a scant  $\frac{1}{4}$ " seam allowance, join the rows to complete the quilt top. Press the seams in one direction, or press them open.

The quilt top will measure  $72\frac{1}{2}$ " x  $72\frac{1}{2}$ ".

We recommend stay-stitching the edges of quilt tops that have a outer pieced borders. To stay-stitch the edge, simply stitch around the quilt top approximately  $\frac{1}{8}$ " away from the raw edge with a regular stitch length.

Quilt and bind as desired.

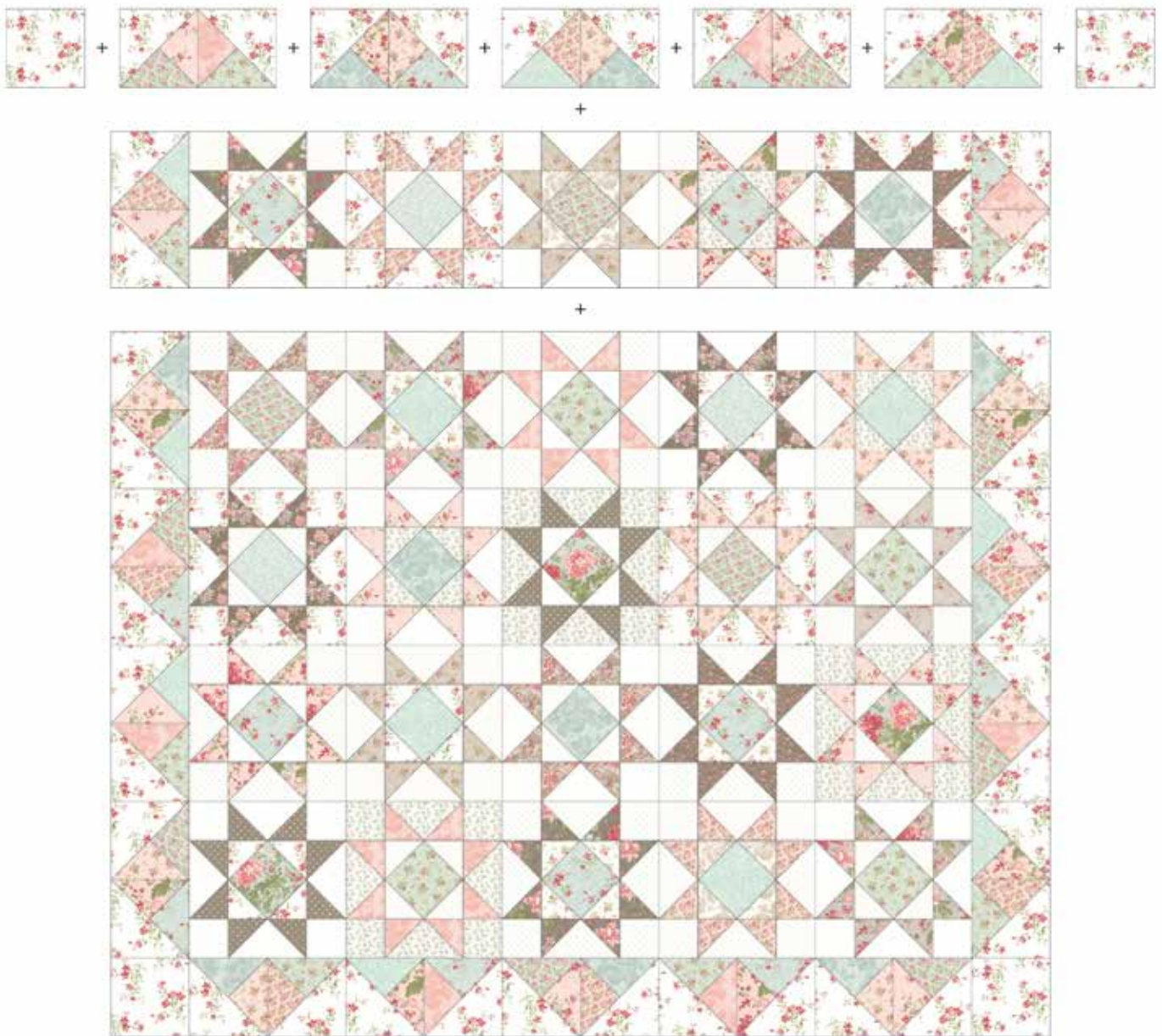

Finished Quilt Layout Diagram

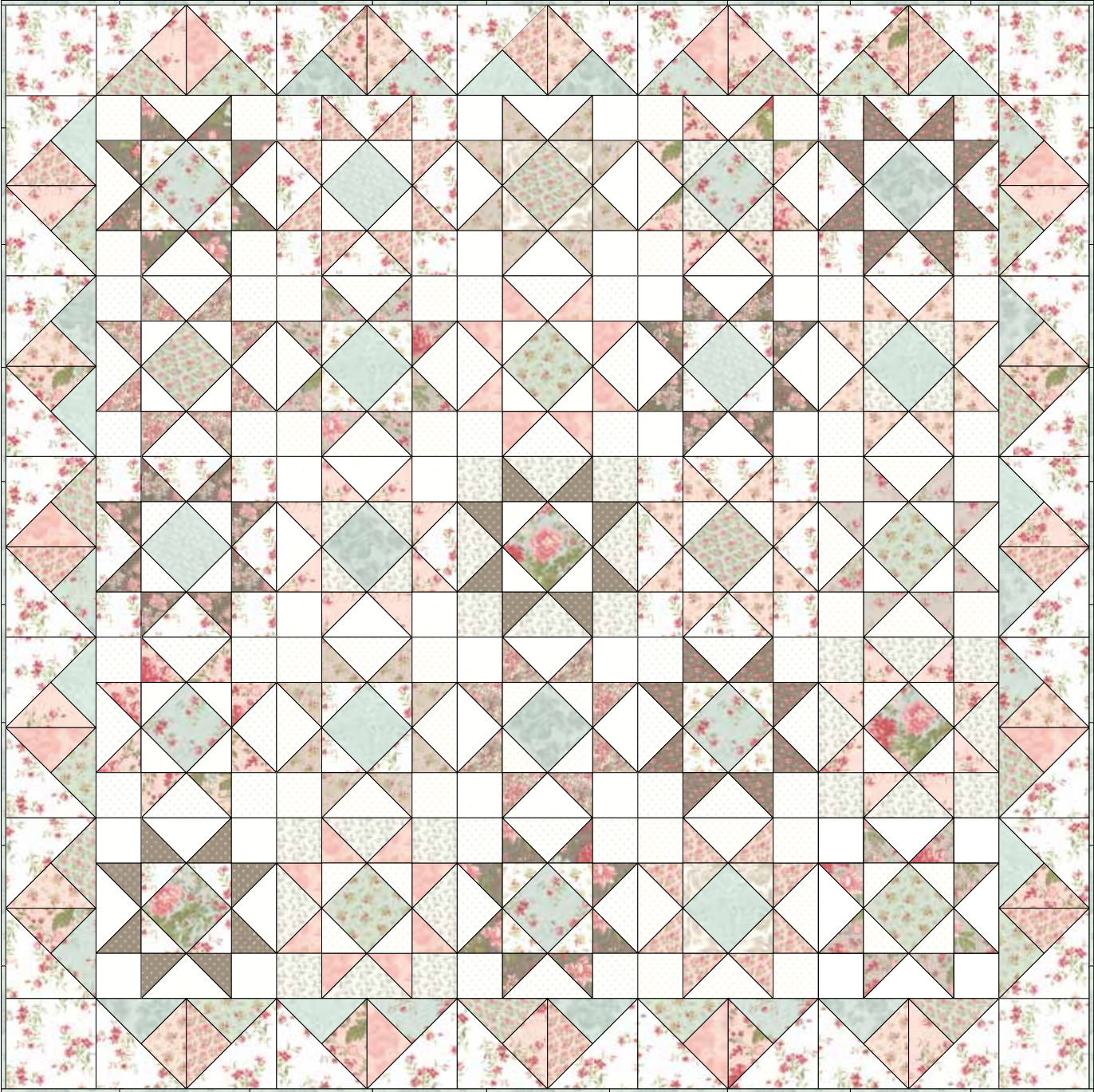

# RUE 1800

72" x 72"

*moda*  
by  
*3 Sisters*

## FABRIC REQUIREMENTS

### BLOCK BACKGROUNDS

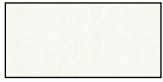

44224 11

**2/3 YARD**

Tone-On-Tone  
Ivory



44226 11

**1/2 YARD**



44228 21

**2/3 YARD**



44228 22

**2/3 YARD**

### BLOCKS



44220 12

**1 FQ**



44220 13

**1 FQ**



44220 14

**1 F8**



44220 15

**1 F8**



44221 11

**1 F8**



44221 12

**1 FQ**



4421 13

**1 FQ**



44222 12

**1 FQ**



44222 14

**1 F8**



44223 12

**1 FQ**



44223 13

**1 FQ**



44223 15

**1 F8**



44224 13

**1 FQ**



44225 12

**1 FQ**



44225 13

**1 FQ**



44225 14

**1 F8**



44226 13

**1 F8**



44227 11

**1 F8**



44227 12

**1 FQ**



44227 13

**1 FQ**



44227 15

**1 F8**



44228 14

**1 F8**

### BACKING



44220 11

**4 1/2 YARDS**

### BINDING



44221 13

**5/8 YARD**

### BLOCKS & BORDER



44223 11

**1 1/2 YARDS**

## IN A QUIET CORNER OF PARIS...

Not far from the banks of the Seine, there is a lovely apartment building that embodies the spirit of the city, especially in the spring. It's been said that Paris is for changing your outlook, for throwing open the windows and letting in la vie en rose. Roses. And pink.

*moda*  
FABRICS + SUPPLIES

MODAFABRICS.COM

PS44220 — SUGGESTED RETAIL \$10.00